



ENDWOOD[®]
CAPPED CELLULAR PVC FENCING

BOARD ON BOARD

INSTALLATION FOR:

Standard 6'H x 8'W Board on Board Fence

5" x 5" Routed Posts

Dog Ear or Straight-Edge Pickets

1.75" x 3.5" Rail

- **Storage and Handling**
- **Fence Preparation and Layout**
- **Locate and Set Posts**
- **Notes on Assembly**
- **Assembly Drawing**
- **Accessories and Tools**
- **Tips**



ENDURIS[®]

Read this instruction guide completely before starting any work.

STORAGE AND HANDLING

PVC can bow toward the sun on the sides exposed to sunlight, therefore if left uncovered and exposed on a sunny day, a bow in the rail or picket will develop. Expansion on the side exposed to the sun is natural so bowing is not unexpected and it can easily be reversed if it does occur. The rails and pickets should be straight before fastening, therefore, it is important to follow the storage and handling guidelines. Once the fence is properly installed, the fence system reinforces and stabilizes the rail & picket components, and, exposure to sunlight will no longer cause excessive bowing. Only direct sunlight causes bowing on warm or cold days, not heat. Follow the procedures below for storing and handling the product before installation.



Important Storage & Handling Guidelines

1. Keep the rails & pickets covered and protected from exposure to direct sunlight – Use bundle packaging to keep it covered - If no bundle packaging is available use other opaque packaging material to keep the product covered and protected from exposure to sunlight.
2. Do not store or place the rails & pickets on their sides or edges at any time before installation - They must be kept flat at all times prior to installation – This will help keep them assembly ready.
3. Keep the rails & pickets with the binding straps on and inside the shipping packaging they were delivered in until ready for installation. Do not to remove fence material from the packaging until it is ready to be installed.



If a Rail or Picket appears Bowed, Follow These Procedures Before Installation:

1. Reverse the bowed rail or picket – lay it flat – with the bowed side away from the sun.
2. Exposure to direct sunlight will straighten the rail or picket out on its own very quickly.
3. The rail or picket can be installed once it has straightened out.
4. The rails must be completely straight before installing to the posts.
5. Make sure to follow Fence Picket Installation Instructions carefully to ensure the pickets are fastened straight and flat to the rails.

TOOLS & MATERIALS NEEDED

Stakes	Drill & Drill Bits	Circular or chop saw - carbide blade, 100+ tooth
Post and gate span jig	Hammer	Pneumatic nail gun (NailPro NPCN 565P)
Touch-up Paint	Straight level - for setting posts	Angle Iron and Quick Clamps
Shovel	String line - for post leveling	Funnel to fill posts with concrete
Post Hole Digger (or Auger)	Picket spacer tool	Garden hose

SECTION 2: PREPARE FENCE LAYOUT

Important: Refer to a specific fence style to determine proper post to post location and gate opening spacing.

Before you begin, there are a few precautions that need to be taken to ensure you do not run into any complications during your fence installation.

1. Before beginning installation, check to ensure that fence footings do not exceed legally established property lines, and that your fence will conform to local code specifications regarding frontage locations and allowable fence heights. Also, be sure to check with local utility companies including water, gas, electricity and sewage for the locations of underground cables or pipelines before digging. Precisely mark the fence layout. This is the critical first step on which a problem-free installation depends.
2. Measure the overall length of your planned fence and determine how many fence sections you will need, locating posts as laid out in the assembly diagram for the style selected. The precise spacing and location of each line and terminal post (terminal posts are corner, end, latch and gate posts) are specific to each style. To ensure the fence is evenly matched with the length of the layout, adjust shorter sections at the corners or near any gates or buildings.
3. Mark the location of each terminal post (Corner, End, and Gate Posts) with a stake. See Fig. A.
 - a. Mark the location of gates and use the gate information from the assembly diagram to assist you in marking the precise spacing and location of gate latch and gate posts.
 - b. Determine the size of each gate in the fence, the gate swing direction (swing-out or swing-in) and the location of the latch and handle on the gate (left or right handed swing).

Note: Endwood pickets and rails may be cut to accommodate shorter spans and terrain adjustments using a circular or chop saw with carbide blade (Minimum 100 teeth).

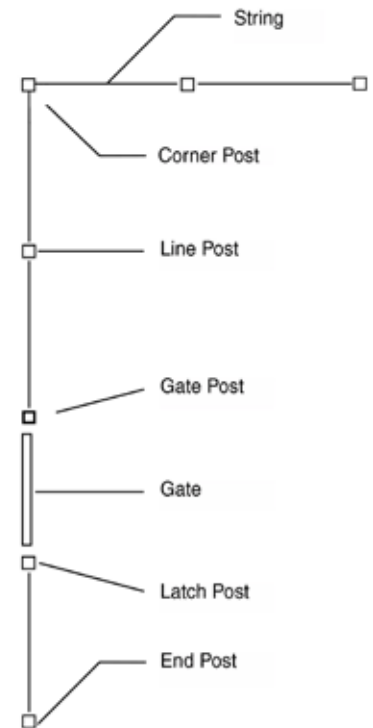

Fig. A

SECTION 3: LOCATE AND SET POSTS

1. Dig terminal post and line post holes below the frost line, typically 30" to 36" deep, with outward sloping sides larger at the bottom, tapered upwards. The depth will be determined by local code requirements, local weather and soil conditions and post height requirements. See Fig. B.
2. Dig the post holes 6" deeper than the required post hole depth then fill the bottom of the hole with a 6" layer of stone to allow for drainage.
3. Position the terminal post in the hole. 5" x 5" posts will require 4 pre-routed holes to allow for concrete flow for the purpose of anchoring the posts into the ground. 4" x 4" posts will require a fastener to secure post sleeve to insert towards the bottom of the post to lock insert and post sleeve. Refer to post height set above ground based on the selected fence style. Center the post in the hole and ensure it is square with the fence line so the rails attached later will parallel the string line as in Fig. C. Also ensure the post is plumb and set at the correct height. Block and support as necessary to preserve post position as installation continues. Utilize a spacer to ensure posts are set at a specific inside post to inside post span to eliminate the need to rip pickets in the field. Surround post with concrete in a continuous pour. Trowel finish around post and slope downward to direct water away.
4. When the terminal post footings have hardened enough to stabilize the posts, stretch a string line taut across the tops of the posts to mark the desired height of the line posts. Set all line posts as described in the preceding steps reinforcing every third post with a steel reinforcement. See Fig. C.

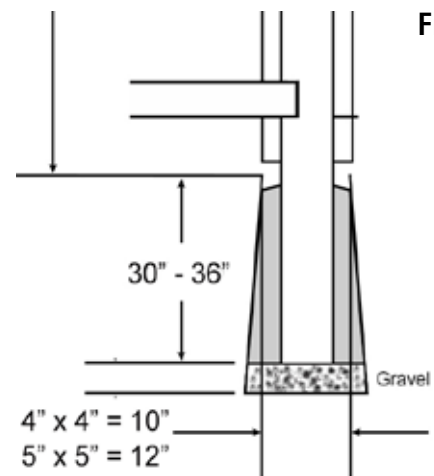

Fig. B

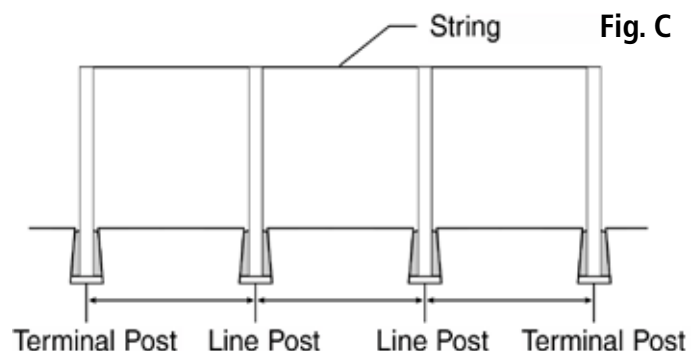

Fig. C

Standard 6'H x 8'W Board on Board 5" x 5" Routed Posts Dog Ear or Straight-Edge Pickets 1.75" x 3.5" Rail

SECTION 4A1: ASSEMBLING BOARD ON BOARD FENCE PANELS

- The following notes are applicable to the fence style as described above. This fence installation is a field built PVC 5" x 5" routed post system where the rails slide into the posts through the routed holes. Routing position based upon style and height of fence.
- Follow general guidelines covered in section #2 for layout.
- POST SPACING** - We recommend using two (2) Endwood rails cut to (93.5") which may be utilized as jigs for post inside to post inside spacing. Measuring in from each end by 1.5", cut a .1875" wide slot half-way through the rail. See Fig. R. To double check for accuracy, the measurement from inside the cut to inside the cut should be 90.5" which equals inside post to inside post spacing. Insert jigs into top routed hole(s) and bottom hole(s) to maintain a consistent spacing between pickets per assembly drawings. This will help prevent the need to rip pickets. Once posts have been set, move jigs to the next section, and repeat.
- The 5" x 5" posts are 108" long. 72" will be above grade and 36" below grade (Do NOT cut the bottom of the posts). 5" x 5" posts will require 4 pre-routed holes (6" and 9" from bottom - See Fig. Q) to allow for concrete flow for the purpose of anchoring the posts into the ground. See assembly drawing for details. Stone is required in the bottom of the post hole to drain off any water running down the post. A 48" Z-shape metal insert is recommended in every third post to add stiffness to the entire fence line. The concrete will also help hold the metal insert in securely.
- If you are using an optional post cap such as a New England style cap, custom posts are required with routed holes 1.5" lower than noted in the assembling drawing.
- INSERT RAILS INTO POSTS** - Secure the top rail between the 5" x 5" posts using rail ties. Measure the middle and bottom rails a minimum 1.5" in from outer edges and mark as indicated in Fig. S.
- Install rails securely into routed holes to the mark. Steel reinforced rails should be utilized in the middle rail per assembly drawing.
- Trim rails as required for specific post setting and make adjustments for grade if needed.
- Prior to attaching pickets, clamp a 1-1/2" x 1-1/2" x 6' long steel L-channel to the top rail with quick clamps. This is used to keep the rails straight while installing pickets preventing the installer from pulling and moving rail during installation. Once pickets are installed, move clamps and L-channel to the next section.
- INSTALL PICKETS** - Use picket leveler spanning posts or a string line to set picket height. Picket spacers may be cut down from pickets using a table saw. A 5" and 4.5" jig will be needed to space pickets. Fastening a small block to one side will allow the jig to hang on the top rail while installing pickets.

TIP



- We recommend nailing the pickets, starting from the top rail moving down towards the bottom rail: Begin with the first back row picket, start with picket flush to post. Drive one (1) nail (Use three (3) 4D x 1.5" or 1.75" ring shank nails per picket) through the center of the picket into each rail. Continue to install the remaining back row of pickets with a space of 4.5" between pickets as shown in the assembly drawing.
- *For the back row of pickets, start with picket flush to post, then continue to install pickets with a spacing of 4.5" between pickets. For the front row of pickets, start with a 5" spacing between the first picket and post. Nail picket in place using six (6) 4D x 1.5" or 1.75" ring shank nails through the outer sides of the picket, the back row of pickets, and into each rail. Continue to install the remaining pickets with a spacing of 4.5" between pickets as shown in the assembly drawing. For front row of pickets, rails are driven in at an angle and should catch both front and back row of pickets plus rail. The nails should not be closer than .5" from the edge of the picket.
- All pickets are installed on the same side of the fence, generally with the rails on the inside of the fenced area. Once all pickets are installed, remove clamps and move to next section - repeat. The last picket installed may be adjusted for spacing and preferred placement.
- The last picket installed within each panel will not have a picket on both sides for support. Therefore, it may be supported by cutting a small piece of picket material and fastening to the last picket adjacent to the post.

Fig. Q

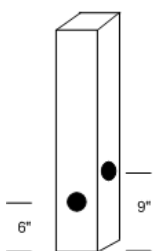

Fig. R

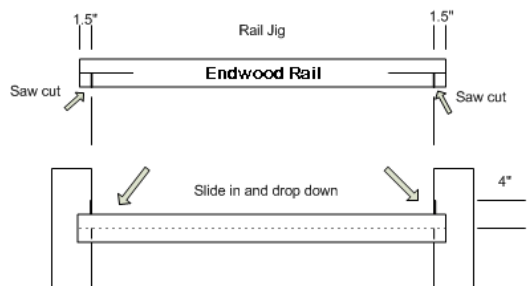
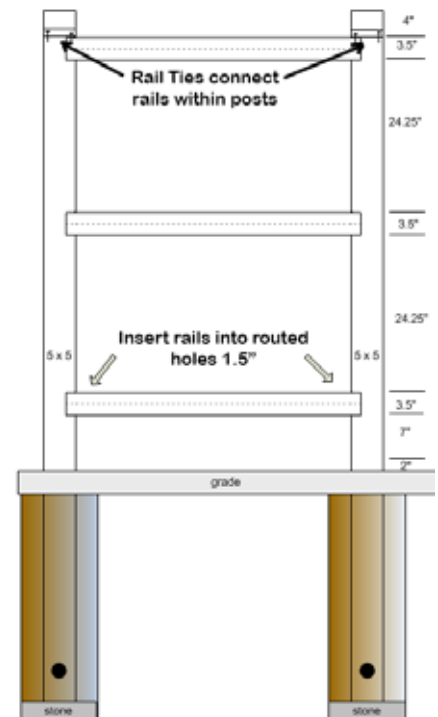
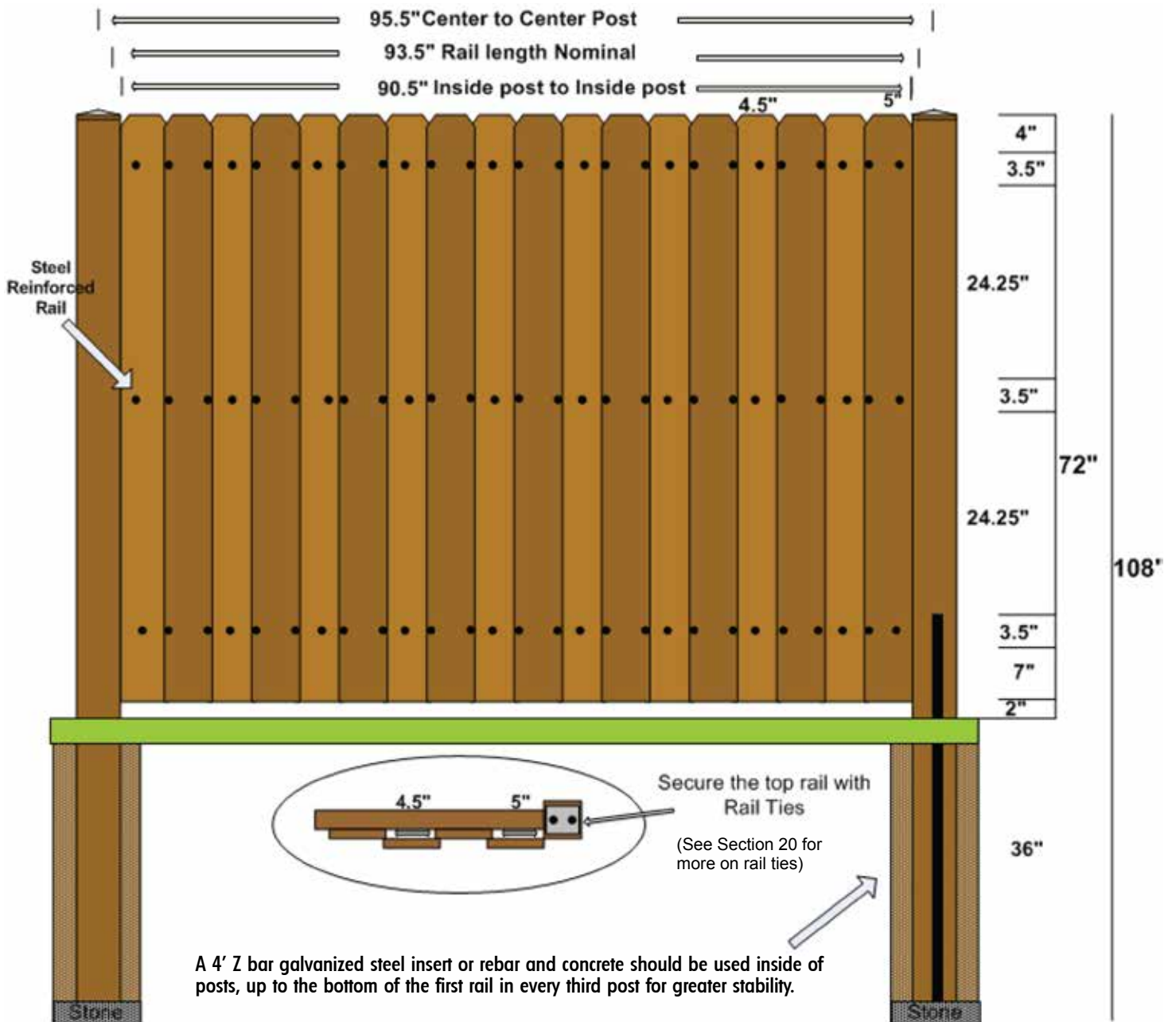

Fig. S



**Standard 6'H x 8'W Board on Board
5" x 5" Routed Posts
Dog Ear or Straight-Edge Pickets
1.75" x 3.5" Rail**

**SECTION 4A2:
ASSEMBLING BOARD ON BOARD FENCE PANELS**



If using an optional post cap such as a New England style cap, custom posts are required with routed holes 1.5" lower than noted in the assembly drawing.

Note from Storage and Handling section: Pickets or rails that have been directly exposed to the sun while working may begin to bow. Remember to turn them over and let them set in the sun for a few minutes to straighten prior to installing. For slight bow in picket, install pickets with bow away from midrail as shown in Fig. T.

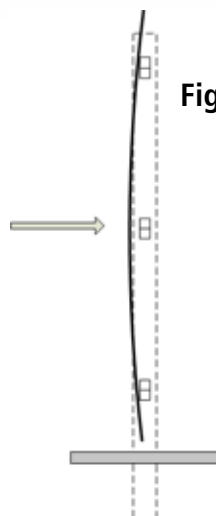
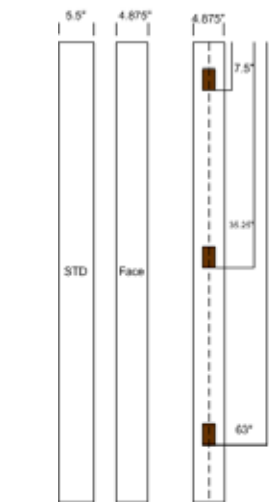
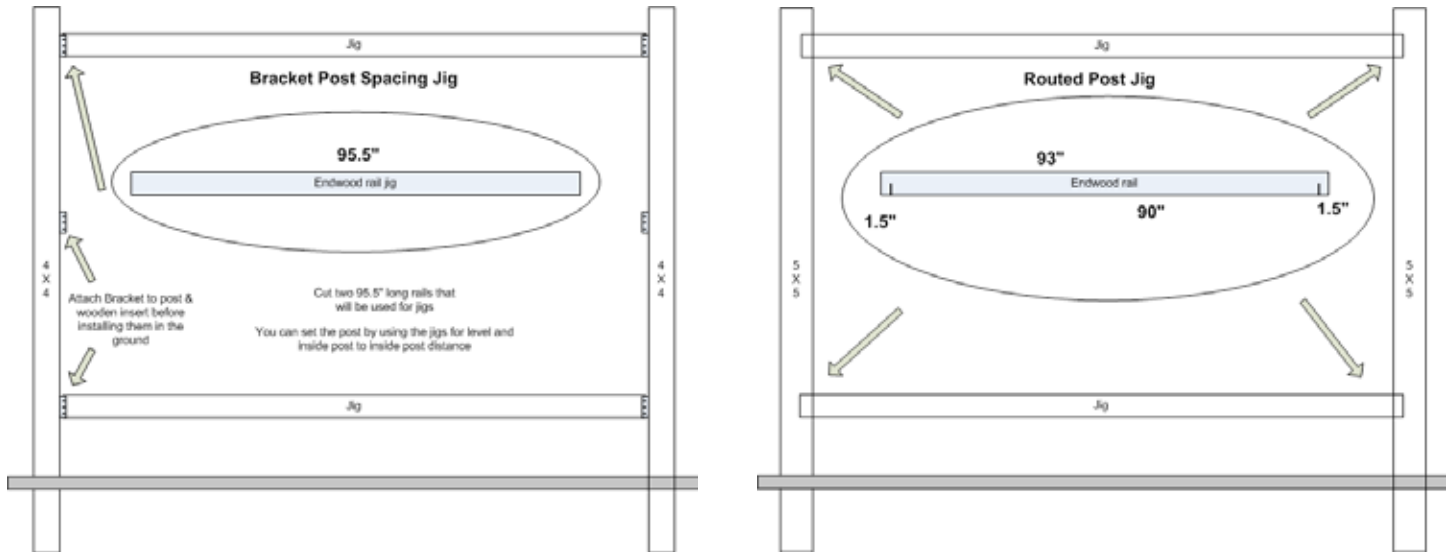

Fig. T

Inside post to inside post spacing: 90.5"
Post hole diameter: 12"
Post height set above ground: 72"
Top Rail: Hollow
Middle Rail: Steel Reinforced
Lower Rail: Hollow
Top Rail Spacing: 4" from top of picket
Bottom Rail Spacing 7" from bottom of picket
*Picket Spacing: Spacing provides 4.5" gaps except for the first picket in the front row which uses a 5" spacing

Post spacing jigs - Used to provide uniform and accurate post spacing.



Create your own Bracket Jig

For standard large 3 rail - 6 ft. privacy fence

Jig Face

Start by taking a standard 5.5' x 70" picket and ripping it down to 4.875"

Mark a center line down the picket

Measure and mark for holes, holes should be 1.9375"L x 3.3125"W

Holes should be placed according to drawing at 7.5", 35.25" and 63" from the top of the picket for standard installation in privacy fence style. See assembly drawings for exact placement per fence style.

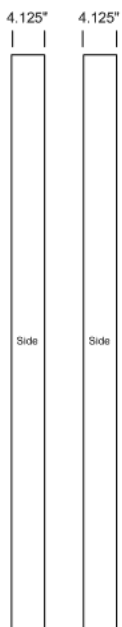

Jig sides

Start by taking two 5.5' x 70" pickets and ripping it down to 4.125"

Line up side panels to face panel evenly

Mount side panels to Jig Face panel using #8, .75" screws



Jig Top

Cut top panel from same material to measure 4.875" x 4.125"

Mount top panel using 4 screws



Mount Jlg onto Post

Place jig securely onto post

Place brackets into jig holes and secure them into place with bracket screws included in bracket kit

Once brackets are secure in post, move jig to next post and repeat

Picket Alignment Guide - Used to keep pickets level during installation

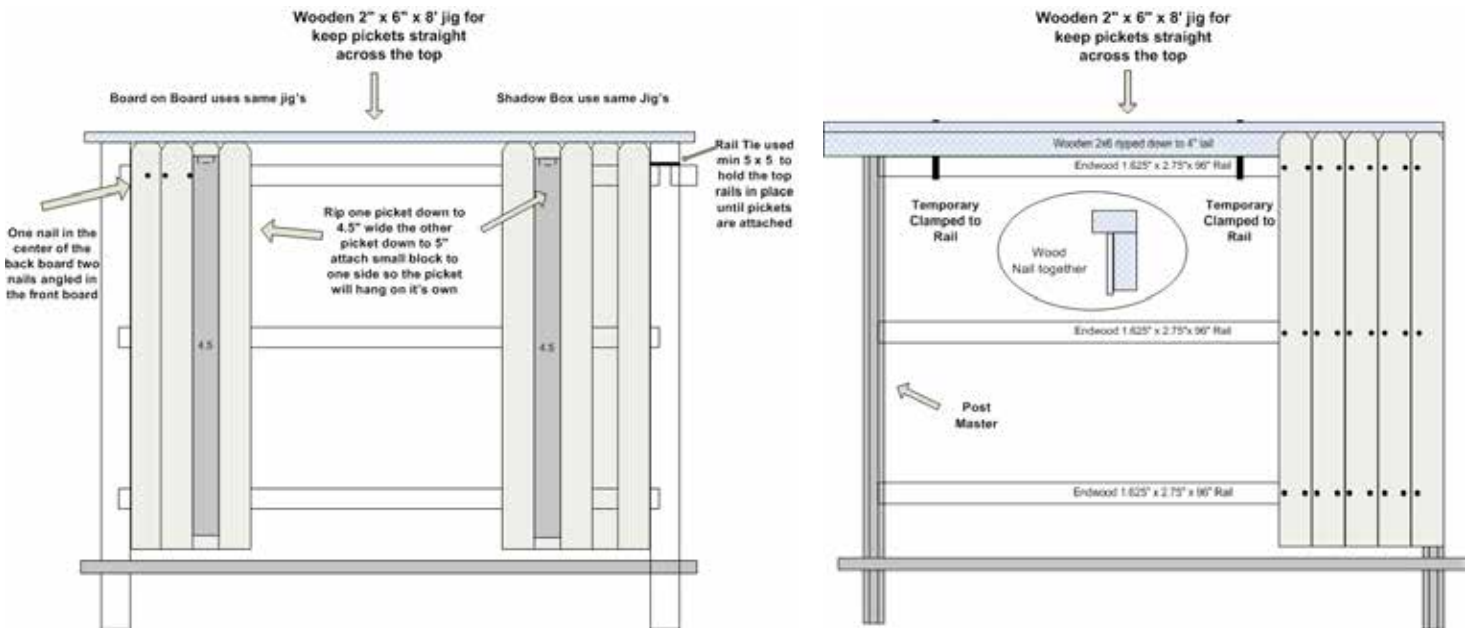

L-Channel - 1.5" x 1.5" x 1/8" - 6 ft. long steel channel used to keep rails straight while installing pickets. Caution - do not put your body weight on rails when installing pickets. One per picket crew. Found in local hardware stores, Home Depot - \$17.94.

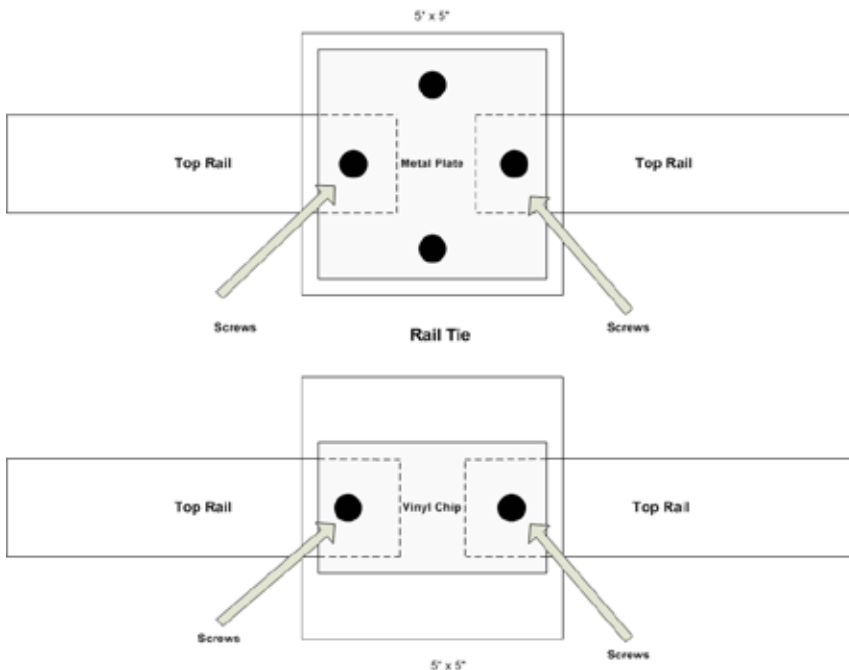

Rail Tie - Metal or Vinyl plate inserted into the top of a 5" x 5" post, attached to the ends of both top rails, securing rails in place.

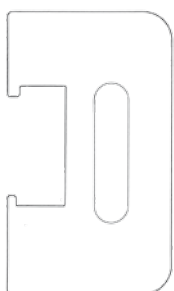

Picket Spacing Jig - Used between pickets in privacy fence styles. Spacer provides a .093" between pickets. Double spacing is used in some fence styles to space the end pickets adjacent to the post. See assembly drawings for details.

If using a steel L channel on the top rail as a guide, you may choose to file the picket spacing jig adding an extra 1/8" to increase the opening to use over the top rail and L channel.

L-Channel for lattice fence

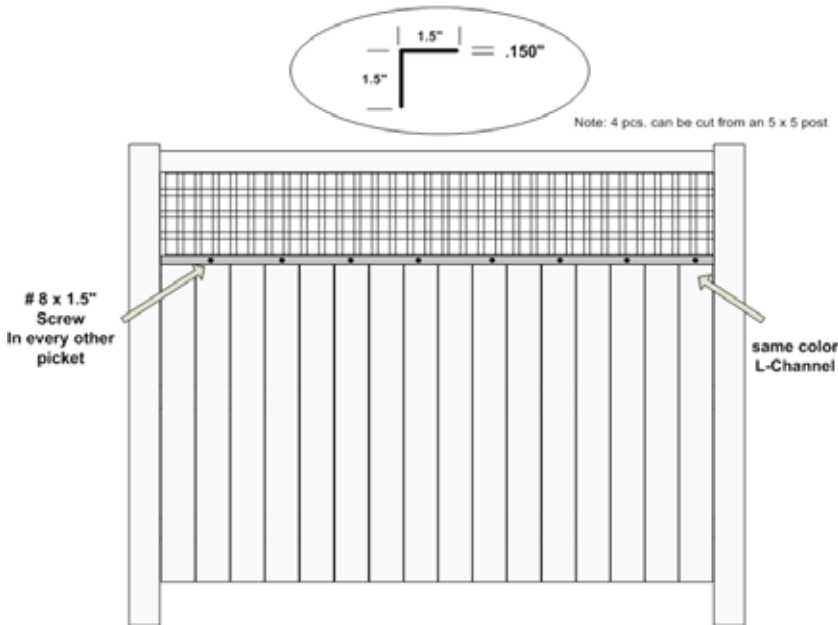

L=Channel for lattice fence styles - An L-Channel is placed upon the upper middle rail and below the lattice insert. The L-Channel is installed to overlap the front fence pickets and fastened at every other picket. See assembly drawings for details.



Mini Quick Clamps - Used to clamp metal L-Channel to top rail. Available in most hardware stores.



Nail Pro-Pneumatic nail gun - Used with nail coils to drive nails through pickets and rails. Available at Enduris.



SUREBONDER 9760 Hand Held Nail Gun - Used on individual nails not driven flush with picket. Hold nail gun over nail, insert over head of nail, and drive nail to be flush with surface of fence panel. Available in most hardware stores.

Storage of Pickets - When installing an Endwood fence, it is important to keep fence components covered and out of direct exposure to the sunlight until ready to use.

Fence Layout - Measure the overall length of your planned fence and determine how many fence sections you will need - placing posts 8 feet apart will provide the most economical spacing. Fence runs will require adjustment of sections to ensure a perfect fit. A simple option is to make adjustments for shorter sections at the corners or near any gates or buildings. To balance the layout for a more customized look, make adjustments to several sections.

Leveling Pickets - By placing a metal L-channel (available at most hardware stores) on top of the top rail, pickets may be quickly installed for level.

Bow in Pickets - Pickets or rails that have been directly exposed to the sun while working may begin to bow. Remember to turn them over and let them set in the sun for a few minutes to straighten prior to installing. For slight bow in picket, install pickets with bow away from midrail.

Nailing Pickets - When nailing pickets, always start on one end of the fence panel, and begin nailing from the top, moving downward. Ensure nails go through the pickets and into the rails. Use six (6) 4D x 1.5" or 1.75" ring shank nails per picket (except back row on board on board fence styles which use three (3), see assembly drawing for details).

Keeping Nails Flush - When using the pneumatic nail gun, nails that are not driven flush to the picket may need to be driven in separately. To avoid denting the picket material, a hand held nail gun may be used to drive the remaining nails to be flush with the fence panel. See page 41 for details.

Rail Distance - Endwood assembly drawings are provided to assist in suggested configurations. Custom configurations can easily be made to create any fence style and design keeping in mind that rails should never be greater than 30" apart.

Post Inserts for 4" x 4" Post Sleeves - Slide Endwood post sleeve over insert paying attention to ensure sides are in alignment with the fence line, and post sleeve and insert are flush at top. Fasten a screw at 2" below grade to secure post to insert and prevent the post sleeve from moving during wet set.

Post Inserts for 5" x 5" Posts - A 4' Z bar galvanized steel insert or rebar and concrete should be used inside of 5" x 5" posts, up to the bottom of the first rail in every third post for greater stability.

Decorative Post Caps - When installing select decorative caps such as New England style, posts will need to be adjusted - raising them 1.5" higher, by lowering routing or bracket placement by 1.5".

Post Caps - Post caps are easily attached and snapped onto the post. A two part epoxy glue may be used to ensure a permanent hold by placing two pea size daubs of glue inside the post cap, and firmly placing it into place on top of the post. Glue excess may be quickly wiped off before it dries.

Extra Tips